

HEAT & GLO®



DESIGNED | to inspire

MULTI-SIDED

Direct Vent & B-Vent Gas Fireplaces

MULTI-SIDED

More Ways to Witness The Power of Fire.

Pushing the boundaries of where fire can go and how it can look, Heat & Glo is the innovative leader in technology, design and safety.

These multi-sided fireplaces present an opportunity to elegantly divide a space, act as a window and provide dramatic architectural elements.

Experience fire more ways. Create your own, unique hearth with a variety of styles, sizes and finishing options.



Cover: Escape See-Through shown with firescreen front in black.
Above: ST-550TM shown with modern front in new bronze.

GAS MULTI-SIDED



ESCAPE SEE-THROUGH

The Escape ST blends masonry style with advanced technology. Powerful, high-efficiency heat production, Direct Vent technology and a flush hearth design create a functional focal point in any room. Take comfort to the next level, and Escape.

Escape-ST shown above with arched firescreen front in black.



SEE-THROUGH

The dramatic see-through designs of these three units provide two-sided fire viewing—and a smart way to bring ambiance into two distinct areas. Enjoy high-efficiency heating, plus finishing options to complement any décor.

ST-36 shown with aero front in black.



CORNER

Accent any room with this versatile and stylish Direct Vent gas unit. Unique, right or left-facing installation options provide an elegant design upgrade. Make it your own with multiple finishing options.

LCOR-36TRB shown with aero front in black.



PIER

The Pier-36TR makes for a magnificent room divider or even the base of a bar. Three dramatic views showcase fireside ambiance from all angles. Enjoy plenty of efficient heat, plus inspiring design options to match your style.

Pier-36 shown with aero front in black and custom tile.



GATEWAY

The Gateway is the first and only B-vent fireplace that can be vented vertically or horizontally. Innovative draft-assist technology and advanced engineering enable endless installation possibilities—so you can savor stunning flames in two separate spaces.

Gateway shown with custom finishing.

DECORATIVE FRONTS AND DOORS

Customize your multi-sided fireplace with one of these fronts or doors.

FRONTS										
	FIRESCREEN	ARCHED FIRESCREEN	AERO	ARCADIA	CHATEAU DELUXE	HALSTON DOORS	GALLERIA DOORS	FOLIO	CF-550	MODERN
ESCAPE SEE-THROUGH	•	•								
ST-36TR			•	•	•	•	•	•		
ST-550T			•		•	•			•	
ST-550TM										•
PIER-36TR			•	•	•					
CORNER			•							
GATEWAY										



Firescreen Front
Available in black, bronze and pewter.



Arched Firescreen Front
Available in black, graphite and new bronze.



Aero Front
Available in black, graphite and new bronze.



Arcadia Front
Available in black, graphite and new bronze.



Chateau Deluxe Front
Available in black, graphite and new bronze.



Halston Operable Doors
Available in black, graphite and new bronze.



Galleria Operable Doors
Available in black, graphite and new bronze.



Folio Front (Inside Fit)
Available in black, graphite and new bronze.



CF-550 Front
Available in black, graphite and new bronze.



Modern Front
Available in black, graphite, new bronze and fog gray.

FINISHES

Five rich finishes. High on style, long on durability.



Black New Bronze Graphite Pewter Fog Gray

FIRESCREEN COMPANIONS

The firescreen front can be enjoyed unadorned, or you can purchase a firescreen companion to attach to the front's exterior. Available in black, bronze or pewter.

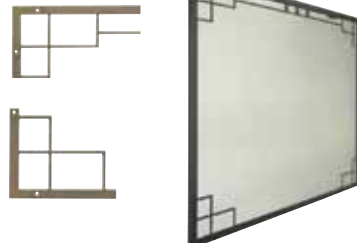

ANDIRONS

Optional andirons are available in black on the Escape See-Through only.



GAS MULTI-SIDED

ELECTRIC EMBER BED

Electric ember beds provide a warm glow with or without flame. Not available on all models. ST-36TR shown.



ST-550TM OPTIONAL GLASS MEDIA

Accent the firebox of the ST-550TM with four cool glass colors.



Crystal Glass



Black Glass



Cobalt Glass



Amber Glass

CONTROL RECOMMENDATIONS

Add a wall or remote control for even more convenience.

CONTROLS					
	RC300-HNG	RCT-MLT-HNG	SMART-STAT-HNG	WSK-MLT	WSK200-HNG
ESCAPE SEE-THROUGH	•				
ST-36TR		•	•	•	•
ST-550T		•	•	•	•
ST-550TM		•	•	•	•
PIER-36		•	•	•	•
CORNER		•	•	•	•
GATEWAY			•		



INTELLIFIRE PLUS RC300 The RC300 incorporates an LCD screen, intuitive menus and large control buttons in a sleek and modern design. This wireless control gives you the flexibility to use as a remote only or mount on the wall anywhere in the room.

Model: RC300-HNG

Features: Auto Battery Backup, Pilot Activation, On/Off, 5 Step Flame Height, Fan Speed (Auxiliary 1), Two Additional Auxiliary Functions, Room Temperature Readout, Thermostat Mode, Timer Mode, Child Lock, Wall Docking Station



TotalRemote This remote control effortlessly manages heat output and comfort level.

Models: RCT-MLT-HNG

Features: Hardwired Receiver, Timer Mode, Thermostat Mode, Room Temperature Readout, Flame High/Low, Fan Speed, On/Off



SmartRemote An added level of function and convenience in a remote control.

Models: SMART-STAT-HNG

Features: Battery-Powered or Hardwired Receiver, Timer Mode, Thermostat Mode, Room Temperature Readout, On/Off



TotalSwitch Command of both comfort and ambiance.

Model: WSK-MLT

Features: Thermostat Mode, Room Temperature Readout, Auxiliary Function, Flame High/Low, Pilot Activation, Fan Speed, On/Off



IntelliSwitch200 Designed exclusively for Heat & Glo fireplaces with IntelliFire®, our state-of-the-art intermittent pilot ignition system.

Models: WSK200-HNG

Features: Auto Battery Backup, Battery Strength Indicator, Pilot Activation, On/Off, Fan Speed

INTELLIFIRE AND INTELLIFIRE PLUS IGNITION SYSTEMS

IntelliFire™ systems constantly monitor ignition, ensure safe functioning and conserve up to \$10/month in energy costs. The IntelliFire Plus Ignition System (IPI Plus) is an advanced intermittent pilot ignition system with memory settings and a programmable wireless control. To learn more about IntelliFire Technology, scan the code to the right with your smartphone, or visit heatnglo.com.



DIRECT VENT TECHNOLOGY

Direct Vent fireplaces remove 100% of combustion exhaust and odors outside of the home. These sealed fireplaces provide optimal heat, conserve energy and ensure clean, safe indoor air quality. To learn more about Direct Vent Technology, scan the code to the right with your smartphone, or visit heatnglo.com.



ESCAPE-ST SPECIFICATIONS

MODEL	FRONT WIDTH		BACK WIDTH		HEIGHT		DEPTH		GLASS SIZE	BTU/HOUR INPUT
	UNIT	FRAMING	UNIT	FRAMING	UNIT	FRAMING	UNIT	FRAMING		
ESCAPE-ST	59-15/16	60-1/4	59-15/16	60-1/4	46-3/8	46-1/2	30	30	39-7/16 x 35-1/8	43,500 - 57,500

TOP VIEW

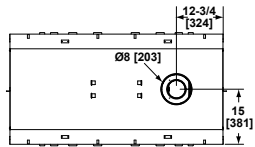

SIDE VIEW

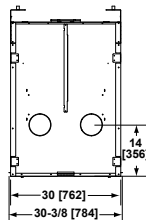

FRONT VIEW

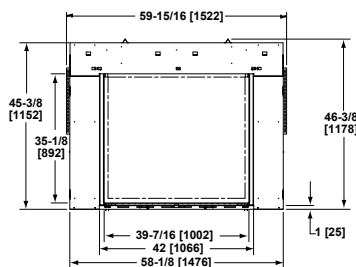

SIDE VIEW

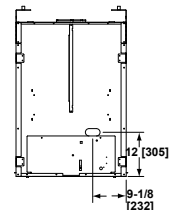

ST-36 SPECIFICATIONS

MODEL	FRONT WIDTH		BACK WIDTH		HEIGHT		DEPTH		GLASS SIZE	BTU/HOUR INPUT
	UNIT	FRAMING	UNIT	FRAMING	UNIT	FRAMING	UNIT	FRAMING		
ST-36TR ST-36TRB	42-1/2	43	42-1/2	43	38	38-1/2	24	23	36 X 24-1/2	26,000 - 37,000

FRONT VIEW

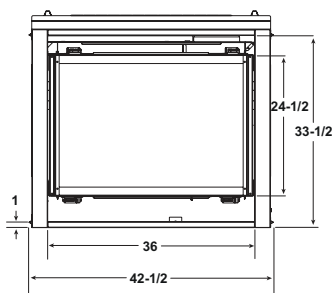

SIDE VIEW

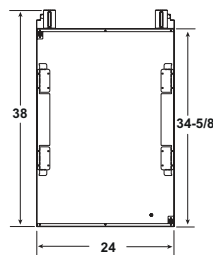

TOP VIEW

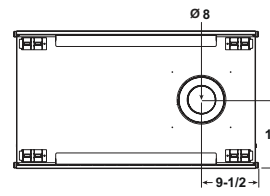

SIDE VIEW

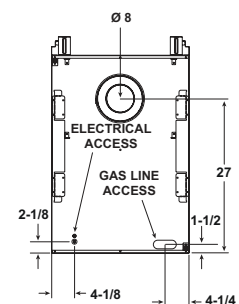

ST-550TM SPECIFICATIONS

MODEL	FRONT WIDTH		BACK WIDTH		HEIGHT		DEPTH		GLASS SIZE	BTU/HOUR INPUT
	UNIT	FRAMING	UNIT	FRAMING	UNIT	FRAMING	UNIT	FRAMING		
ST-550TM	37-5/8	38-1/8	37-5/8	38-1/8	41-1/4	41-1/2	16	15	31 X 21	16,000 - 22,000

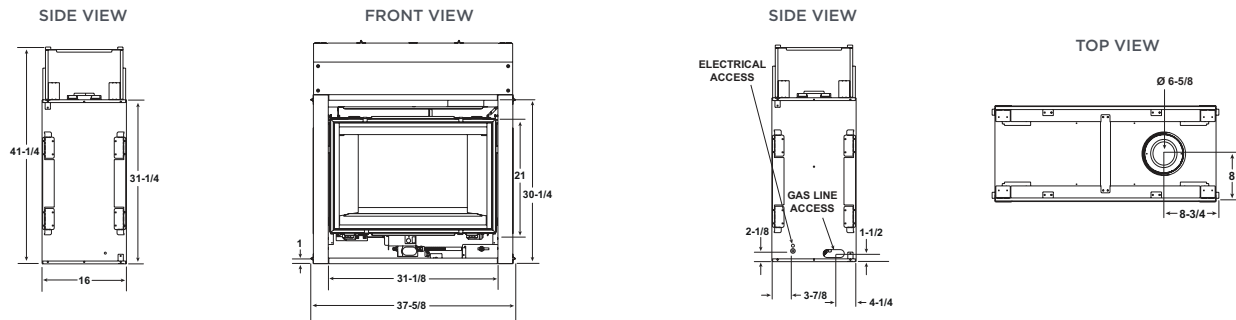

ST-550T SPECIFICATIONS

MODEL	FRONT WIDTH		BACK WIDTH		HEIGHT		DEPTH		GLASS SIZE	BTU/HOUR INPUT
	UNIT	FRAMING	UNIT	FRAMING	UNIT	FRAMING	UNIT	FRAMING		
ST-550T	37-5/8	38-1/8	37-5/8	38-1/8	34-1/2	34-3/4	16	15	31 X 21	14,700 - 21,000

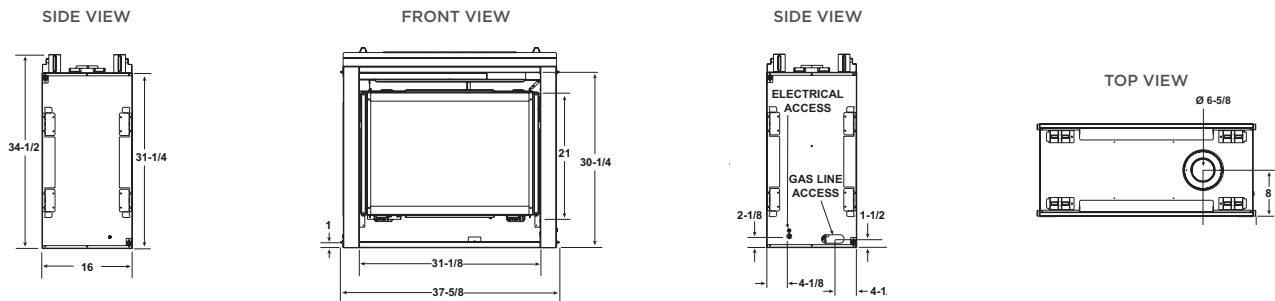

PIER SPECIFICATIONS

MODEL	FRONT WIDTH		BACK WIDTH		HEIGHT		DEPTH		GLASS SIZE	BTU/HOUR INPUT
	UNIT	FRAMING	UNIT	FRAMING	UNIT	FRAMING	UNIT	FRAMING		
PIER-36TR PIER-36TRB	40-1/2	40	40-1/2	40	38	38-1/8	24	23	36 X 24-1/2	26,000 - 37,000

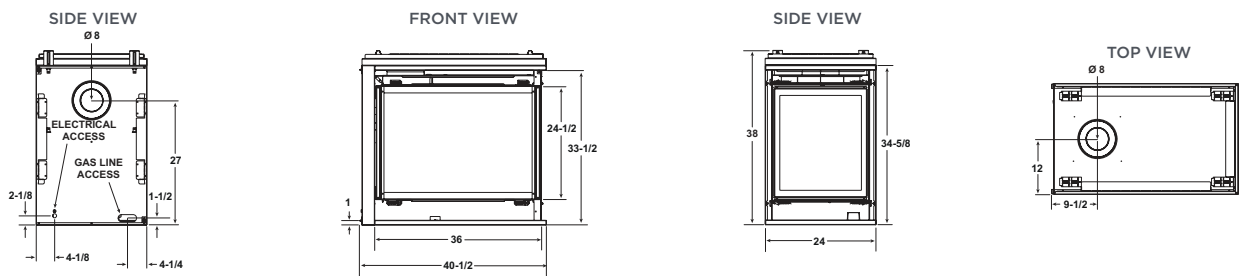

Dimensions shown are in inches. Reference dimensions only. We recommend measuring individual units at installation. Assumes the use of 1/2" Sheetrock. NOTE: Non-combustible material is allowed over this dimension. Make sure you do NOT cover the decorative door opening.

Refer to installation manual for detailed specifications on installing this product. Heat & Glo reserves the right to update units periodically. The flame and ember appearance may vary based on the type of fuel burned and the venting configuration used. Pictures in this brochure are not true representation of the fireplace, flames and/or finishes.

CORNER SPECIFICATIONS

MODEL	FRONT WIDTH		BACK WIDTH		HEIGHT		DEPTH		GLASS SIZE	BTU/HOUR INPUT
	UNIT	FRAMING	UNIT	FRAMING	UNIT	FRAMING	UNIT	FRAMING		
LCOR-36TRB RCOR-36TRB	40-1/2	40	40 -1/2	40	38	38-1/8	24-1/2	24	36 X 24-1/2	26,000 - 37,000

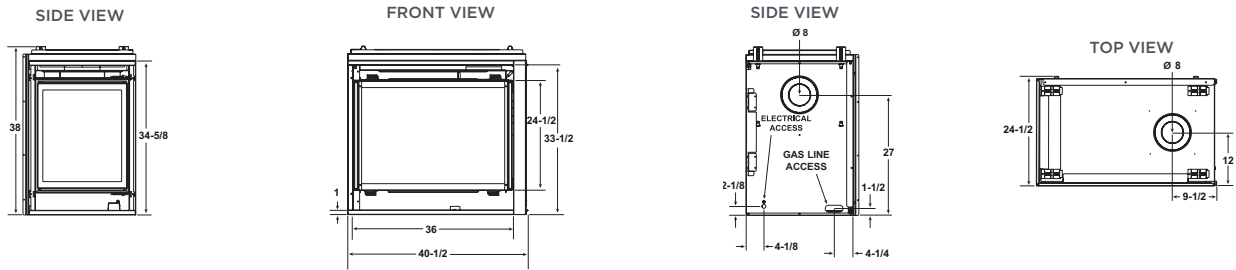

GATEWAY SPECIFICATIONS

MODEL	FRONT WIDTH		BACK WIDTH		HEIGHT		DEPTH		GLASS SIZE	BTU/HOUR INPUT
	Actual	Framing	Actual	Framing	Actual	Framing	Actual	Framing		
GATEWAY	39-1/4	40-1/4	39-1/4	40-1/4	39-3/16	40-1/4	22-5/8	21-5/8	30-1/4 X 20-3/4	35,000

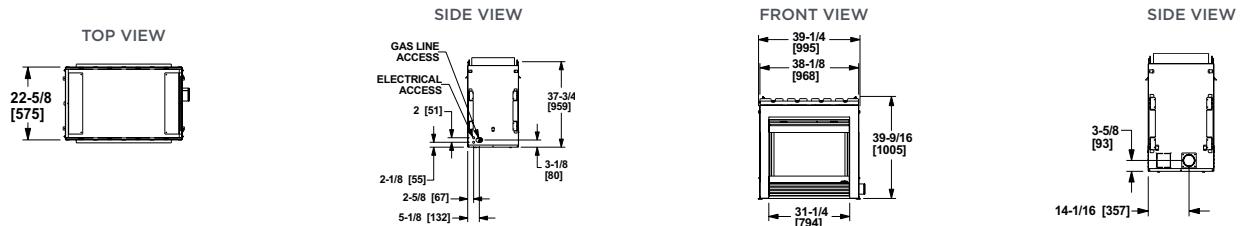

Dimensions shown are in inches. Reference dimensions only. We recommend measuring individual units at installation. Assumes the use of 1/2" Sheetrock. NOTE: Non-combustible material is allowed over this dimension. Make sure you do NOT cover the decorative door opening.

Refer to installation manual for detailed specifications on installing this product. Heat & Glo reserves the right to update units periodically. The flame and ember appearance may vary based on the type of fuel burned and the venting configuration used. Pictures in this brochure are not true representation of the fireplace, flames and/or finishes.

U.S. EFFICIENCIES

Steady State - Since most homeowners use their fireplaces for an extended time while they are in the room, Steady State measures how efficiently your fireplace converts fuel to heat once it is warmed up and running in a "steady state".

AFUE - AFUE rating is more typically used with appliances, like your furnace, that continually cycle on and off to maintain a constant temperature.

RATING	ESCAPE-ST	ST-36TVB	ST-36TR/TRB	ST-55OT/TM	PIER-36TR/TRB	L/RCOR-36TRB	GATEWAY
STEADY STATE	69.3%	N/A	72%	74%	75%	72%	N/A
AFUE	60.5%	N/A	59%	47%	68%	59%	N/A

CANADA EFFICIENCIES

EnerGuide (CSA P.4.1-02) - EnerGuide is a rating used in Canada to measure annual fireplace efficiency.

RATING	ESCAPE-ST	ST-36TVB	ST-36TR/TRB	ST-55OT/TM	PIER-36TR/TRB	L/RCOR-36TRB	GATEWAY
ENERGUIDE (CSA P.4.1-02)	62.5%	N/A	61%	51%	63%	61%	N/A

For complete information on this model, please contact us at:

HEAT & GLO

No one builds a better fire

A brand of Hearth & Home Technologies®

7571 215th Street West, Lakeville, MN 55044

Web: heatnglo.com

Phone: (888) 427-3973 (952) 985-6000

E-mail: info@heatnglo.com

[facebook.com/HeatandGlo](https://www.facebook.com/HeatandGlo)

twitter.com/HeatandGlo

[youtube.com/HeatandGlo](https://www.youtube.com/HeatandGlo)

LIMITED LIFETIME WARRANTY*

The strongest in the industry, Heat & Glo provides a limited lifetime warranty on the most important aspects: firebox and heat exchanger.

*For full warranty details, go to www.heatnglo.com. Fireplace glass and other surfaces get extremely HOT and can cause severe burns if touched. Do not remove the protective safety screen from the front of the glass. Keep a safe distance away. To learn more visit www.heatnglo.com/fireplacesafety.



HNG-1034U-0813

