

— & —  
**TRUE**

DIRECT VENT GAS FIREPLACES





TRADITIONAL STYLE  
AT ITS BEST

# TRUE

The best fire. The cleanest look. The largest view. It is TRUE.  
The most authentic masonry appearance available is here.

## BIG IMPACT

The largest viewing areas in their class command attention. Crisp edges and tight finishing completes the clean look.

## BOLD FIRES

Vivid flames rise to life through an illuminated ember bed with LED accent lighting. Enjoy the ambiance with or without the fire.

## DISTINCTIVE DETAILS

For the most authentic appearance, we turned up the detail. High definition logs. Glowing embers. Brick interior panels. Add a touch of modern with reflective black glass interior panels. Witness it all through virtually invisible, anti-reflective glass and control it with IntelliFire™ Touch—the most intuitive control system that is simple, smart and safe.



LEFT: TRUE shown with forge front and herringbone interior with custom surround

COVER: TRUE shown forge front and herringbone interior



*TRUE shown with firescreen front in new bronze and fade-resistant black glass interior*

**MODELS AVAILABLE**

Three models. And the right size for your space.



**TRUE 36**  
Shown with firescreen front in new bronze and stratford interior.



**TRUE 42**  
Shown with firescreen front in black and fade-resistant black glass interior.



**TRUE 50**  
Shown with firescreen arch front in new bronze and herringbone interior.

FEATURES	TRUE 36	TRUE 42	TRUE 50
Fireplace Width	36"	42"	50"
Room Size Fit	Medium	Medium to large	Large
BTU/hr Input	28,000 to 45,500	30,500 to 55,500	36,000 to 65,000
Interior Panel Options	Stratford or herringbone brick panels or fade-resistant reflective black glass panels	Stratford or herringbone brick panels or fade-resistant reflective black glass panels	Stratford or herringbone brick panels
Remote Control	Standard	Standard	Standard
Wall Switch	Optional	Optional	Optional
Logs	Seven high-definition logs	Eight high-definition logs	Nine high-definition logs
Embers	LED illuminated embers	LED illuminated embers	LED illuminated embers
Accent Lighting	LED accent lighting	LED accent lighting	LED accent lighting
Glass	Virtually invisible anti-reflective ceramic	Virtually invisible anti-reflective ceramic	Virtually invisible anti-reflective ceramic
Ignition System	IntelliFire™ Touch	IntelliFire™ Touch	IntelliFire™ Touch
Flame Turndown	50%	50%	50%

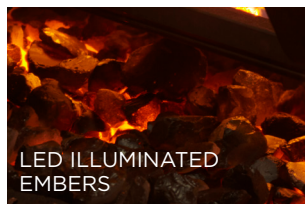
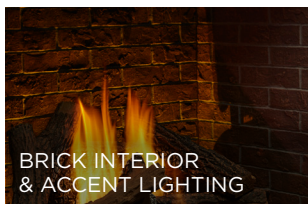

## FRONT OPTIONS

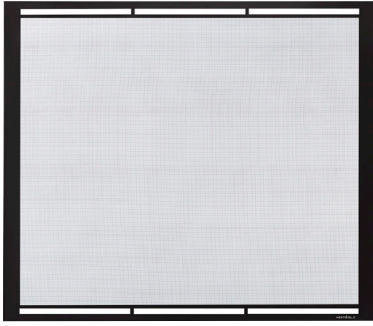

### FIRESCREEN

Available in black, new bronze or graphite finishes.

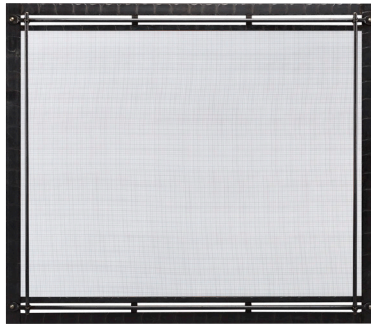

### FORGE

Available in hand-crafted, hammered steel.

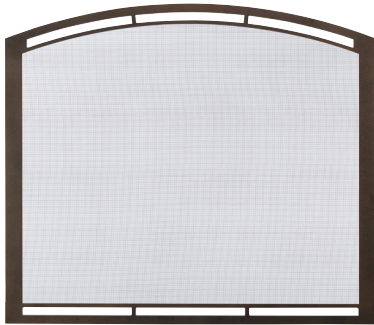

### FIRESCREEN ARCH

Available in black, new bronze or graphite finishes.

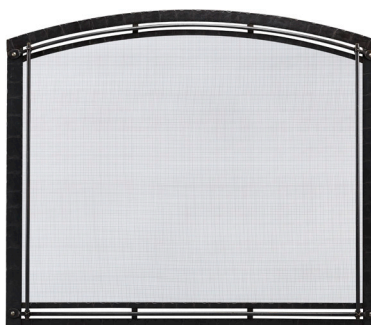

### FORGE ARCH

Available in hand-crafted, hammered steel.

## FINISHES

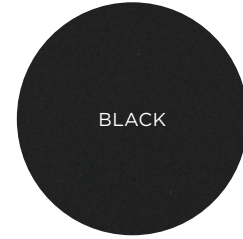

BLACK



NEW  
BRONZE

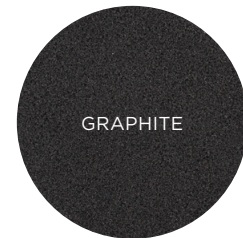

GRAPHITE

## INTERIOR OPTIONS

Change the look of the fireplace with interior panel options. Choices range from brick panels that give the appearance of an authentic masonry fireplace, to reflective fade-resistant black glass for modern drama.



STRATFORD



HERRINGBONE



FADE RESISTANT  
BLACK GLASS

## CONTROL OPTIONS

Have complete control over your fire. Controls listed are tested and approved for recommended use with your TRUE.

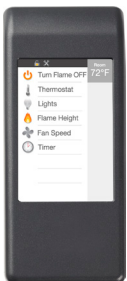

### INTELLIFIRE TOUCH RC400 TOUCHSCREEN REMOTE CONTROL

**Included standard with the TRUE**, a large LCD screen and simple navigation provide easy operation. Feel confident knowing alerts and notifications will appear when needed. The RC400 acts as a thermostat and can be used as a remote, or docked on the wall.

**Features:** on/off, flame height adjustment, fan speed, lights adjustment, thermostat mode, room temperature readout, child lock, timer mode, automatic battery backup, cold climate mode, power vent, wall docking station (Fan, lights and power vent are dependent on your fireplace).



### INTELLIFIRE TOUCH RC150 WIRELESS WALL SWITCH

Push the switch for fire and ambiance, while audible feedback confirms commands and ensures safe functioning. This simple switch is designed for wall placement.

**Features:** on/off, battery strength indicator, automatic battery backup, cold climate mode

## MANTEL SHELVES

A shelf mantel is the perfect accent to a fireplace and a place to showcase some of your most cherished mementos. Available in 48, 59 or 72-inch lengths in a variety of finish options.



GIFFORD



OZARK



FILLMORE

## TRUE TECHNOLOGIES



### INTELLIFIRE TOUCH IGNITION SYSTEM

IntelliFire Touch is the most advanced and intuitive IntelliFire system, making operating your fireplace simple, smart and safe. Select the wireless wall switch or touchscreen remote control for the solution that fits your life.



### DIRECT VENT TECHNOLOGY

Direct Vent fireplaces remove 100% of combustion exhaust and odors outside of the home. These sealed fireplaces provide optimal heat, conserve energy and ensure clean, safe indoor air quality.



### ANTI-REFLECTIVE GLASS

A cleaner, more distinct view of the fire. A glare reduction of 89% over standard ceramic glass, making it virtually invisible. And an experience so real, friends may just try and add a log to the fire.



### HEAT MANAGEMENT TECHNOLOGY

Bring the warmth from your fireplace to the rest of your home, up to 20 feet away. Heat management technology can redirect up to 50% of the heat to another area, also reducing wall temperatures above the fireplace. Choose between a **Heat-Zone™ kit** to transfer heat where you want it, or utilizing your existing furnace ductwork with a **Heat Duct kit**.

Draw heat from your fireplace and direct it outside, up to 25 feet away. When an **Heat Out kit** is run continuously on high, it can redirect up to 40% of the heat off the fireplace, also reducing wall temperatures above the fireplace.

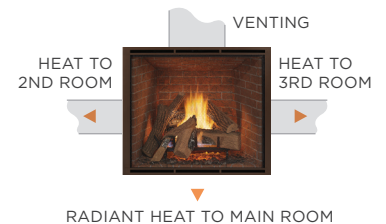

### POWER VENT TECHNOLOGY

No matter where you want to install your gas fireplace, power venting technology makes it possible. This extremely flexible, versatile technology is small enough to effectively navigate your home to an effective vent location, which in turn provides you with optimal performance, every time.



### LED ACCENT LIGHTING

Superior performance and extended efficiency. This technology provides high-contrast, brilliant lighting to accentuate the flames. Can be used as mood lighting, with or without the flames.



### LED EMBER BED

Add an extra layer of dimension and light to your fire. Realistic illuminated LED embers let you enjoy the ambiance, with or without the fire.



### FADE-RESISTANT BLACK GLASS PANELS

A clean modern look that reflects the fire and never gets dull. Just like this black glass interior. It's hot. And looks that way, too. For the life of your fireplace.

## TRUE SPECIFICATIONS

MODEL	FRONT WIDTH		BACK WIDTH		HEIGHT		DEPTH		GLASS SIZE	BTU/HOUR INPUT (NG)
	UNIT	FRAMING	UNIT	FRAMING	UNIT	FRAMING	UNIT	FRAMING		
TRUE-36	61 [1549]	59-1/2 [1511]	59-1/4 [1505]	59-1/2 [1511]	57-5/8 [1464]	56 [1422]	24 [610]	24 [610]	35-7/8 x 31-1/16 [911 x 789]	28,000 - 45,500
TRUE-42	67 [1702]	65-9/16 [1665]	65-5/16 [1659]	65-9/16 [1665]	62-5/8 [1591]	61 [1549]	24 [610]	24 [610]	41-7/8 x 36-1/16 [1064 x 916]	30,500 - 55,500
TRUE-50	75 [1905]	73-9/16 [1869]	73-5/16 [1862]	73-9/16 [1869]	66-5/8 [1692]	65 [1651]	24 [610]	24 [610]	49-7/8 x 40-1/16 [1267 x 1018]	36,000 - 65,000

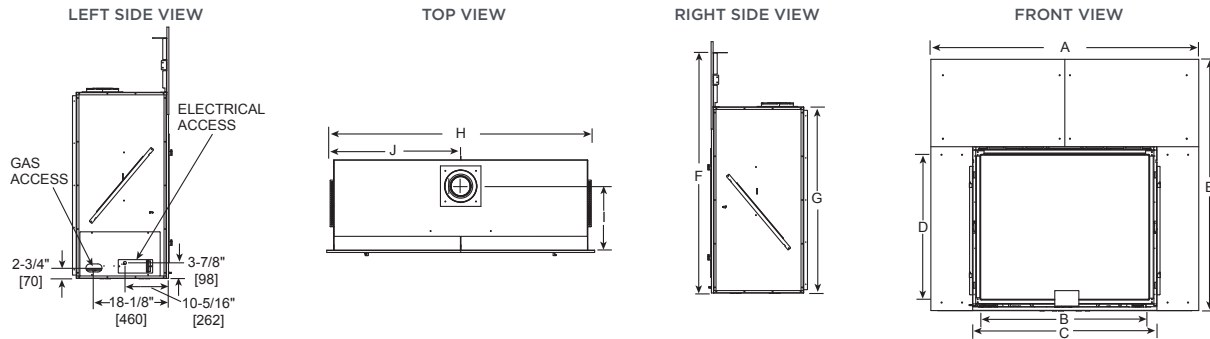

Model	A	B	C	D	E	F	G	H	I	J
TRUE-36	61" [1549]	35-7/8" [911]	39-7/8" [1013]	31-1/16" [789]	57-5/8" [1464]	54-15/16" [1395]	41-3/8" [1042]	59-1/4" [1505]	16" [406]	29-5/8" [752]
TRUE-42	67" [1702]	41-7/8" [1064]	45-7/8" [1165]	36-1/16" [916]	62-5/8" [1591]	59-15/16" [1522]	46-3/8" [1178]	65-5/16" [1659]	16" [406]	32-11/16" [830]
TRUE-50	75" [1905]	49-7/8" [1267]	53-7/8" [1368]	40-1/16" [1018]	66-5/8" [1692]	63-15/16" [1624]	50-3/8" [1280]	73-5/16" [1862]	16" [406]	36-11/16" [932]

\*Front dimensions include non-combustible material which overlaps framing

Dimensions are in inches and millimeters. Product information is not complete and is subject to change without notice. Product installation must adhere strictly to instructions shipped with product. We recommend measuring individual units at installation. Assumes the use of 1/2" sheetrock. NOTE: Combustible material should not cover the face. Make sure you do NOT cover the decorative door opening.

Refer to installation manual for detailed specifications on installing this product. Heat & Glo® reserves the right to update units periodically. The flame and ember appearance may vary based on the type of fuel burned and the venting configuration used. Actual product appearance, including flame, may differ from product images.

## U.S. EFFICIENCIES

**Steady State** - Since most homeowners use their fireplaces for an extended time while they are in the room, Steady State measures how efficiently your fireplace converts fuel to heat once it is warmed up and running in a "steady state".

**AFUE** - AFUE rating is more typically used with appliances, like your furnace, that continually cycle on and off to maintain a constant temperature.

RATING	TRUE-36	TRUE-42	TRUE-50
STEADY STATE	76.2% (NG), 76.2% (LP)	77.2% (NG), 77.2% (LP)	68.9% (NG), 67.3% (LP)
AFUE	51.9% (NG), 55.3% (LP)	67.0% (NG), 67.6% (LP)	66.8% (NG), 65.2% (LP)

## CANADA EFFICIENCIES

**EnerGuide (CSA P.4.1-02)** - EnerGuide is a rating used in Canada to measure annual fireplace efficiency.

RATING	TRUE-36	TRUE-42	TRUE-50
ENERGUIDE (CSA P.4.1-02)	57.6% (NG), 57.1% (LP)	67.0% (NG), 68.4% (LP)	69.1% (NG), 66.5% (LP)

For complete information on this model, please contact us at:

# HEAT & GLO®

No one builds a better fire

Web: [heatnglo.com](http://heatnglo.com)  
 Phone: (888) 427-3973 (952) 985-6000  
 E-mail: [info@heatnglo.com](mailto:info@heatnglo.com)

[facebook.com/HeatandGlo](https://www.facebook.com/HeatandGlo)  
[twitter.com/HeatandGlo](https://twitter.com/HeatandGlo)  
[youtube.com/HeatandGlo](https://www.youtube.com/HeatandGlo)

HNG-1119U-0217

## LIMITED LIFETIME WARRANTY\*

The strongest in the industry, Heat & Glo® provides a limited lifetime warranty on the most important aspects: firebox and heat exchanger.

\*For full warranty details, go to [www.heatnglo.com](http://www.heatnglo.com).

Fireplace glass and other surfaces get extremely HOT and can cause severe burns if touched. Do not remove the protective safety screen from the front of the glass. Keep a safe distance away. To learn more visit [www.heatnglo.com/fireplacesafety](http://www.heatnglo.com/fireplacesafety)

